

Data Sheet

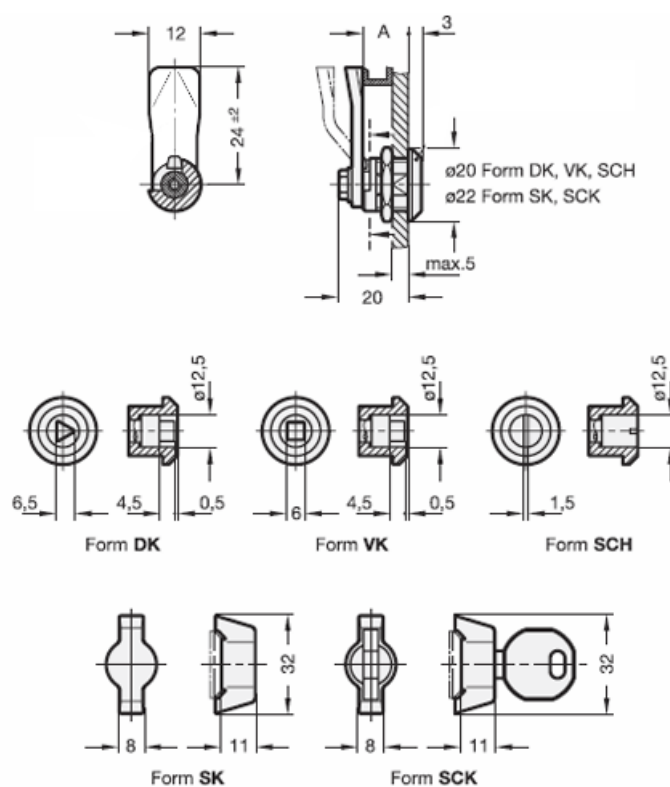

Article number: 201591019
Description: E+G Mini latch
GN 115.6-SCH-19,5

Measures



A = 19.5